

Accessories

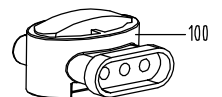

210

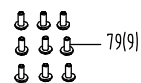

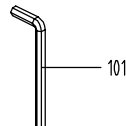
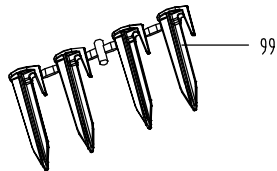
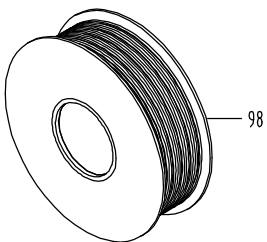
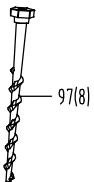
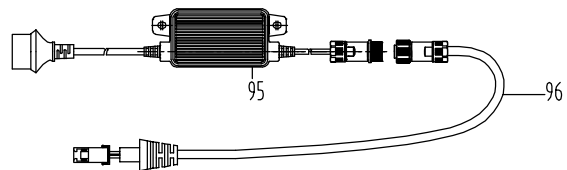
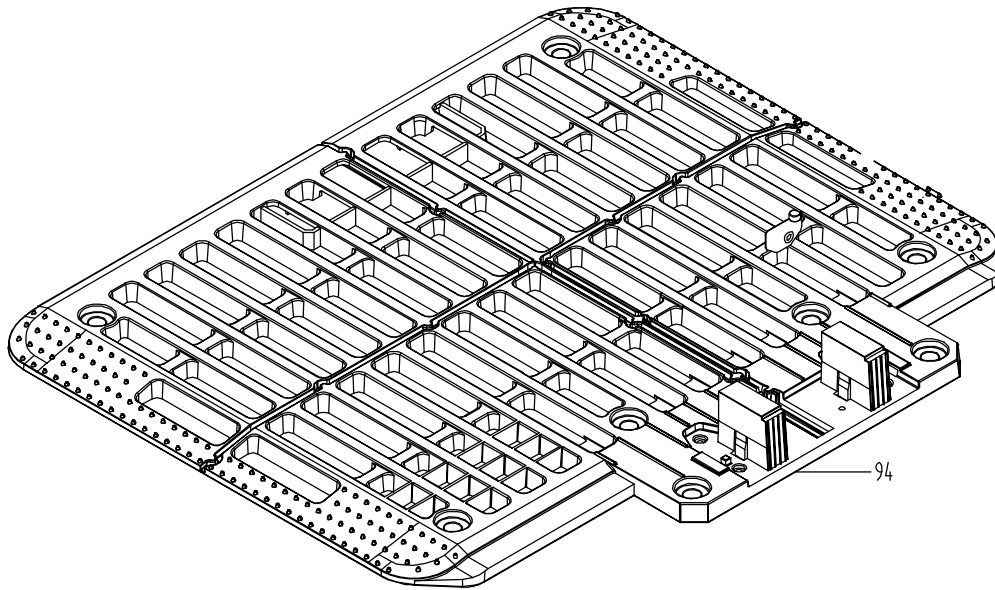
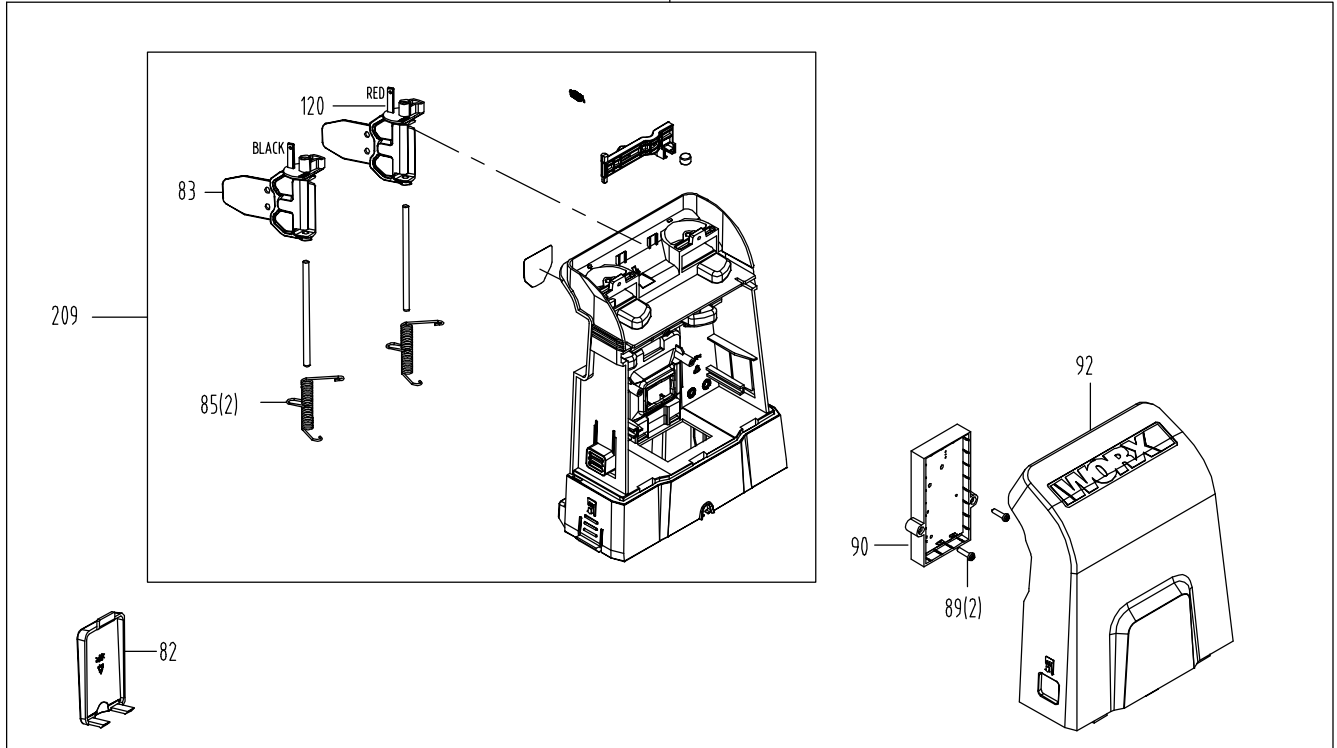
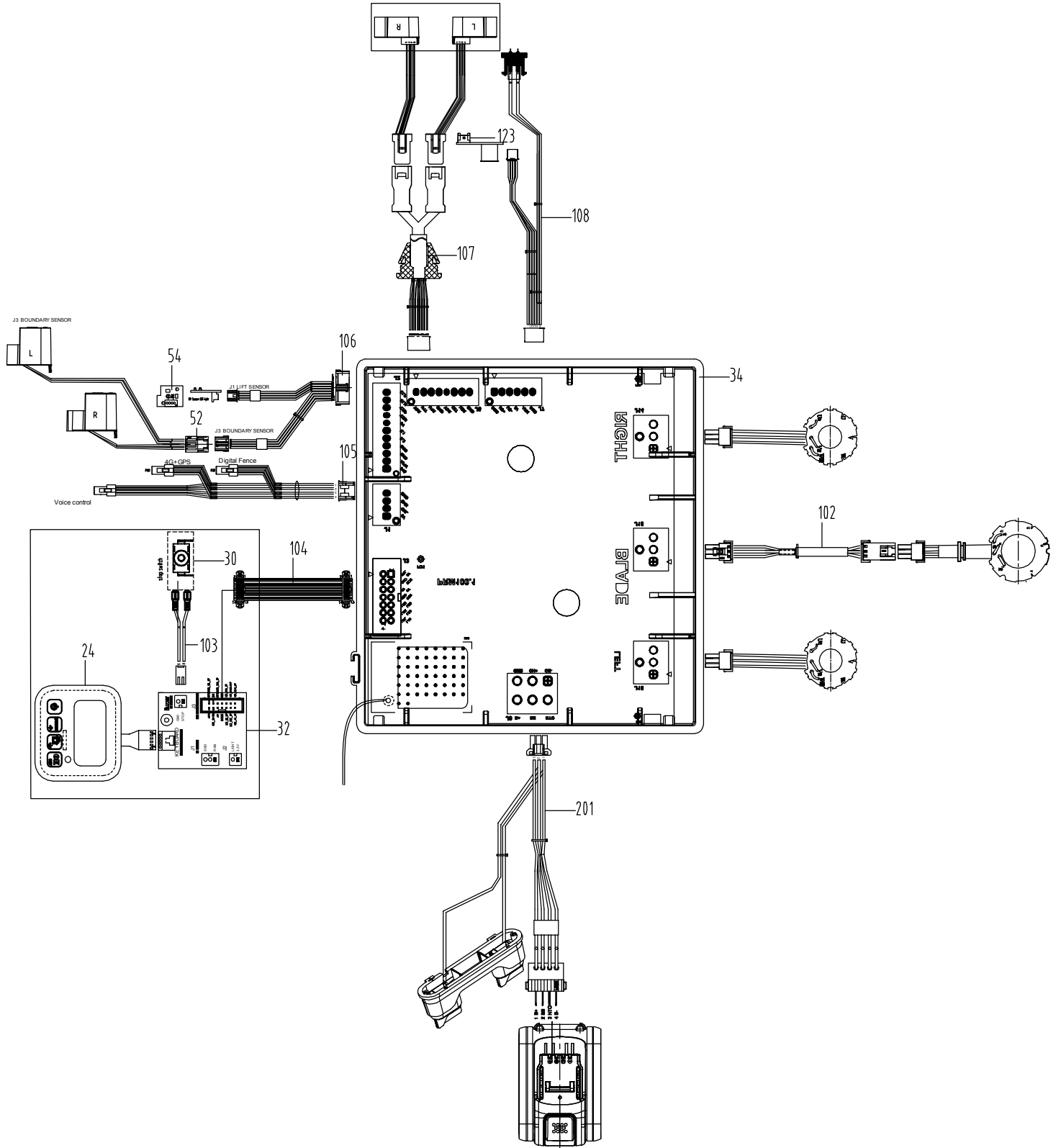

Model	Pos. Nr.	Part. Nr.	Descrizione	Description	Q.tà	Serial no.
WR141E	1	50037134	MUSETTO C/PROTEZIONE LATERALE	Ornament Cover	1	
WR141E	3	50031651	VITE AUTOFIETTANTE	Self Tapping Screw	9	
WR141E	4	50036918	ETICHETTA	Rated Label	1	
WR141E	5	50036912	PROTEZIONE	Fence	1	
WR141E	6	50023010	RONDELLA GRANDE	Big washer	1	
WR141E	7	50036851	VITE AUTOFIL. ST4.8 x 20	Self tapping screw ST4.8*20	13	
WR141E	9	50037022	PIASTRINA	Decorative Cover	1	
WR141E	10	50037137	GUARNIZIONE SPORTELLO	Sealing Strip	1	
WR141E	11	50037025	BASE CHIUSURA MAGNETE	Washer	2	
WR141E	12	50029086	VITE AUTOFIETTANTE ST3P5X10	Self Tapping Screw ST3P5X10	2	
WR141E	13	50037138	SUPPORTO SPORTELLO	Revolve Shaft	1	
WR141E	14	50037032	PERNO DELLO SPORTELLO	Output Spindle	1	
WR141E	15	50036908	MOLLA TORSIONALE	Torsional Spring	1	
WR141E	16	50037031	SUPPORTO	Damping Block	1	
WR141E	17	50036894	COPERCHIO	Cover	1	
WR141E	18	50036885	COPERCHIO	Decorative Cover	1	
WR141E	20	50037027	PULSANTE STOP	Button Set	1	
WR141E	21	50037028	GANCIO	Linkage	1	
WR141E	22	50036863	VITE ST3.9X13	Screw ST3.9x13	1	
WR141E	22	50032717	VITE AUTOFIETTANTE	Self tapping screw	1	
WR141E	23	50037139	BLOCCO DI FISSAGGIO	Fixing Block	1	
WR141E	24	50036900	TASTIERA	Keyboard film	1	
WR141E	25	50036886	COPERCHIO SENSORE ULTRAS.	Ultrasonic decorative cover	1	
WR141E	27	50037030	MAGNETE	Magnet	2	
WR141E	28	50036878	GUARNIZIONE DI TENUTA (STOP)	Seal sleeve(STOP)	1	<202030198411003941
WR141E	28	50026060	GOMMINO INTERRUTTORE	Sheath II	1	>=202030198411003941
WR141E	29	50018399	RONDELLA	Washer	1	
WR141E	30	50036880	INTERRUTTORE	Switch	1	<202030198411003941
WR141E	30	50040504	INTERRUTTORE	Switch	1	>=202030198411003941
WR141E	31	50000976	RONDELLA	Washer	2	
WR141E	32	50041411	SCHEDA COMANDI	Transfer board	1	>=202030198411003941
WR141E	32	50036890	SCHEDA DISPLAY	Transfer board	1	<202030198411003941
WR141E	33	50036842	LINGUETTA	Press plate	1	
WR141E	34	50045467	SCHEDA MADRE LANDROID	Main Board	1	
WR141E	35	50036909	COPERTURA DEL CAVO	Cable Cover	1	
WR141E	36	50037048	BATTERIA LITIO 2.0AH 20V	Battery Pack(Li-ion,2.0Ah,20V) WA3551.3	1	
WR141E	38	50026099	GOMMINO	Rubber Pin	2	
WR141E	40	50036903	GUARNIZIONE DI TENUTA	Seal Gasket	1	
WR141E	41	50037035	GUARNIZIONE DI TENUTA	Seal Gasket	1	
WR141E	42	50037142	SPUGNA	Sponge	1	
WR141E	44	50036844	MANICOTTO PER CAVI	Cable Sleeve	3	
WR141E	45	50034397	FERMAGLIO	Wire clip	3	
WR141E	47	50037036	SPUGNA	Sponge	5	
WR141E	48	50037038	COPERCHIO	Cover	1	
WR141E	49	50032535	PARAOLIO	Oil Seal Bearing	1	
WR141E	50	50023507	RONDELLA	Washer	2	
WR141E	51	50036897	RUOTA ANTERIORE PIVOTTANTE	Front Wheel Assembly	1	
WR141E	52	50036840	SENSORE PERIMETRO	Boundary sensor	1	
WR141E	53	50040167	COPRIMOZZO RUOTA ANTERIORE	Front wheel end cover	1	
WR141E	54	50036879	SENSORE DI SOLLEVAMENTO	Lift sensor	1	
WR141E	55	50032327	MAGNET	Magnet	1	
WR141E	56	50028034	MAGNETE	Magnet	1	
WR141E	57	50023969	RONDELLA	Retaining Ring	1	
WR141E	58	50036855	MOLLA DI COMPRESSIONE	Compression Spring	4	
WR141E	61	50036892	MOTORE RUOTE	Motor	2	
WR141E	61	50037046	MOTORE RUOTE	Drive motor Assembly	1	<202030198410002259,
WR141E	62	50037047	RIDUTTORE	Gearbox assembly	1	<202030198410002259,
WR141E	63	50037044	VITE AUTOFIL ST3.9 x 55	Self Tapping Screw ST3.9*55	3	
WR141E	64	50037916	VITE AUTOFIETTANTE ST4.825	Self Tapping Screw ST4.8*25	8	<202030198410002259,
WR141E	64	50040738	VITE AUTOFIETTANTE	Self Tapping Screw	8	>=202030198410002259,

Model	Pos. Nr.	Part. Nr.	Descrizione	Description	Q.tà	Serial no.
WR141E	65	50024699	RUOTA POSTERIORE ARTIGLIATA	Rear Wheel	2	
WR141E	66	50036910	ZAVORRA	Counterweight	2	
WR141E	67	50028148	RONDELLA ELASTICA	Spring Washer	2	
WR141E	68	50028149	DADO	Nut	2	
WR141E	69	50036906	COPRI RUOTA	Roller Guard	2	
WR141E	76	50036898	RASTRELLO	Guard Assembly	1	
WR141E	77	50024710	DISCO PORTACOLTELLI	Turning disc	1	<202030198410002259,
WR141E	77	50042880	DISCO PORTACOLTELLI	Clutch Drum And Housing	1	>=202030198410002259,
WR141E	79	50022577	VITE LAMA LANDROID	Screw	12	
WR141E	80	50024711	RONDELLA BLOCCO PIATTO LAME	Spacer	1	
WR141E	81	50040365	VITE C/RONDELLA M4 X 14	Screw Washer Assembly M4*14	3	>=202030198410002259,
WR141E	81	50022575	VITE AUTOFILETTANTE	Screw Washer	3	<202030198410002259,
WR141E	82	50032343	COPERCHIO IN PLASTICA	Clip Plate	1	
WR141E	83	50044333	TERMINALE (NERO)	Terminal(Black)	1	>=202130198401011156
WR141E	85	50032541	MOLLA DI TORSIONE	Torsional Spring	2	
WR141E	89	50032718	VITE	Screw	2	
WR141E	90	50044335	SCHEDA STAZIONE DI RICARICA	Power panel assembly	1	>=202130198401011156
WR141E	91	50032352	SWITCH BOX	Switch Box	1	
WR141E	92	50044420	COPERCHIO TORRETTA	Guard	1	>=202130198401011156
WR141E	94	50043732	PIASTRA DI BASE	Base Plate	1	>=202130198401011156
WR141E	95	50046800	ALIMENTATORE(100-240V,20V,38W)	Charger(100-240V,20V,38W)WA3755.1	1	
WR141E	96	50043723	CAVO ALIMENTATORE	Cable Assembly	1	>=202130198401011156
WR141E	97	50026445	VITE PER FISSAGGIO BASE	Screw	8	
WR141E	98	50036889	MATASSA CAVO PERIMETRO	Spool&line(130m)	1	
WR141E	99	50027715	SET PICCHETTI (180 PZ)	Cable clips (180pcs)	1	
WR141E	100	50032719	CONNETTORE CAVO PERIMETRO	Boundary wire connector	2	
WR141E	101	50002339	CHIAVE BRUGOLA 5	Spanner	1	
WR141E	102	50036843	CABLAGGIO MOTORE	Cut motor connection Wire harness	1	
WR141E	103	50036872	CABLAGGIO ELETTRICO (STOP)	Stop Wiring harness	1	
WR141E	104	50036873	CABLAGGIO SCHEDA DISPLAY	Transfer plate Wiring harness	1	
WR141E	105	50036902	CABLAGGIO ACCESSORI	Can Bus	1	
WR141E	106	50036888	CABLAGGIO SENSORI PERIM. E SOL	Lift boundary sensor harness	1	
WR141E	107	50036868	CABLAGGIO SENSORE ULTRASUONI	Ultrasonic wire harness	1	
WR141E	108	50036854	CABLAGGIO SENSORE PIOGGIA	Rain wire harness	1	
WR141E	109	50036895	GUARNIZIONE	Seal foam for Sound inlet	2	
WR141E	110	50037171	MOLLA PULSANTE STOP	Press reset spring	1	
WR141E	120	50044332	TERMINALE (ROSSO)	Terminal(Red)	1	>=202130198401011156
WR141E	121	50034891	O RING	O ring	1	
WR141E	122	50021254	RONDELLA	Washer	3	
WR141E	123	50036905	PRESA USB	Control Board	1	
WR141E	201	50036887	CABLAGGIO BATTERIA	Power wire harness	1	
WR141E	202	50036891	SCOCCA	Pedestal Assembly	1	<202030198410002259,
WR141E	202	50044600	PIEDISTALLO CPL	Pedestal Assembly	1	
WR141E	203	50036861	MANOPOLA REGOLAZIONE ALTEZZA	Height Adjustment Knob	1	
WR141E	204	50037225	SET MOTORE	Motor set	1	<202030198410002259,
WR141E	204	50044368	SET MOTORE LAMA	Motor set	1	>=202030198410002259,
WR141E	205	50032396	SET LAME E VITI (3+3PZ)	Cutting blades and screws(3+3pcs)	1	
WR141E	207	50044634	COPERCHIO SUPERIORE CPL	Top Cover Assembly	1	>=202030198411003941
WR141E	207	50044185	COPERCHIO SUPERIORE CPL	Top Cover Assembly	1	<202030198411003941
WR141E	208	50037055	PORTA BATTERIA	Battery pack interface assembly	1	
WR141E	209	50044334	SUPPORTO BASE	Base Holder	1	>=202130198401011156
WR141E	209	50040107	TORRETTA DI RICARICA	Base Holder	1	>=201930198407003176,
WR141E	209	50034259	TORRETTA RICARICA	Base Holder	1	<201930198407003176,
WR141E	210	50044423	TORRETTA STAZIONE DI RICARICA	Charge station assembly(w/o base)	1	>=202130198401011156
WR141E	211	50041466	MOTORE RUOTA COMPLETO	Gear Case Set	2	